

For use with JJM® V-Series
 V-125, V-250

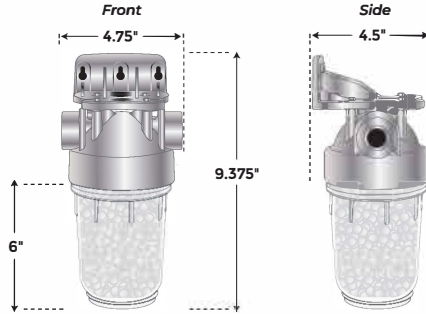

Model: V-125
Part No.: 4008
Weight (lbs.): 3

Specification: The condensate neutralizer shall be part number 4008 by JJM Alkaline Technologies.
Included Parts: System shall include (1) vertical canister made from corrosion resistant materials with (2) access openings (inlet/outlet), (1) wall bracket, (2) 3/4" male adapter MIPT x socket. pH Power Pellets® included.



Model: V-250
Part No.: 4000
Weight (lbs.): 5

Specification: The condensate neutralizer shall be part number 4000 by JJM Alkaline Technologies.
Included Parts: System shall include (1) vertical canister made from corrosion resistant materials with (2) access openings (inlet/outlet), (1) wall bracket, (2) #10 x 3/4" self-drilling screws, (2) 1/2" x 3/4" male adapter MIPT x socket. pH Power Pellets® included.

pH POWER PELLETS® REFILLS

Model: V-125R
Part No.: 4001

Model: V-250R
Part No.: 4003

Project:
Engineer:
Unit:

Location:
Contractor:
Submitted by: